

RotoSpense 360

Effortless 360° Dispensing of Adhesives

- Semi-automated, bench-top design with compact footprint
- Adjustable for various tube diameters (4 mm - 20 mm)
- Features I/O outputs and part processing data capture
- Eliminates time and waste associated with manual dosing
- Increases quality, repeatability, and efficiency
- Dual-integrated Model 455 valves for highly precise dispensing
- ISO-compliant device sealing and bonding via precision dispensing

The RotoSpense 360 is specifically engineered to efficiently dispense a 360° bead of adhesive around the outer diameter of tubes. This significantly reduces the time and resources wasted on manual adhesive dosing in tube set applications. This system is ideal for bench-top and semi-automated work centers typically found in low-volume equipment production and laboratory environments. It is designed to solve application based challenges commonly found in the industrial or medical markets, such as catheter tube bonding. By harmonizing operations across in-line manufacturing processes, it establishes a standard of uniformity and consistency in tube set and catheter assembly, promoting reliability and efficiency.

Modular in design, the workstation allows for various size tubes to receive a 360° bead of material at the end of tubing, ensuring a no-leak pathway when assembled into mating connectors. Using this system helps reduce operator fatigue from continuous manual application and increases overall process efficiency.

With its integration of two Model 455 valves, the RotoSpense 360 enables precise control over material flow, ensuring accurate and repeatable dispensing. In addition, its use of disposable fluid paths prevents the dispensed material from contacting the valve's inner components, facilitating easy material changeover with minimal cleanup.

For customers that require a tailored solution, Dymax offers customizable tube bonding systems for high-mix and variable-volume applications that require precision in quality and control.

System Features & Benefits

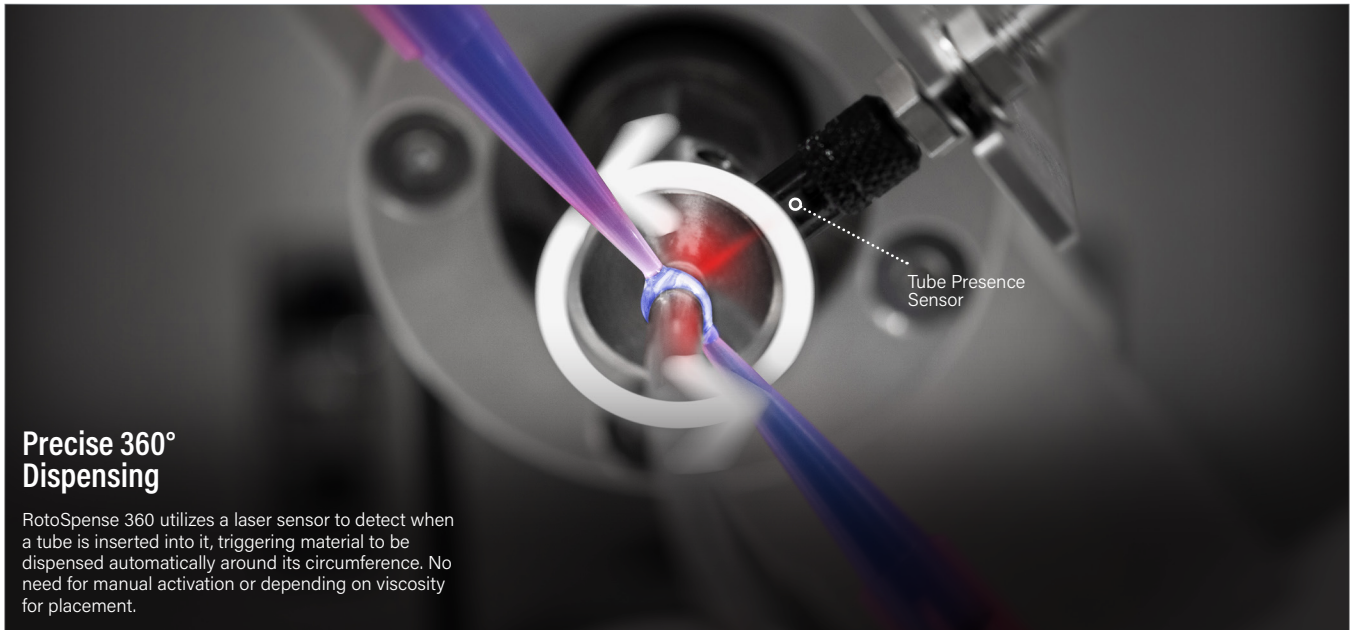

Precise 360° Dispensing

RotoSpense 360 utilizes a laser sensor to detect when a tube is inserted into it, triggering material to be dispensed automatically around its circumference. No need for manual activation or depending on viscosity for placement.

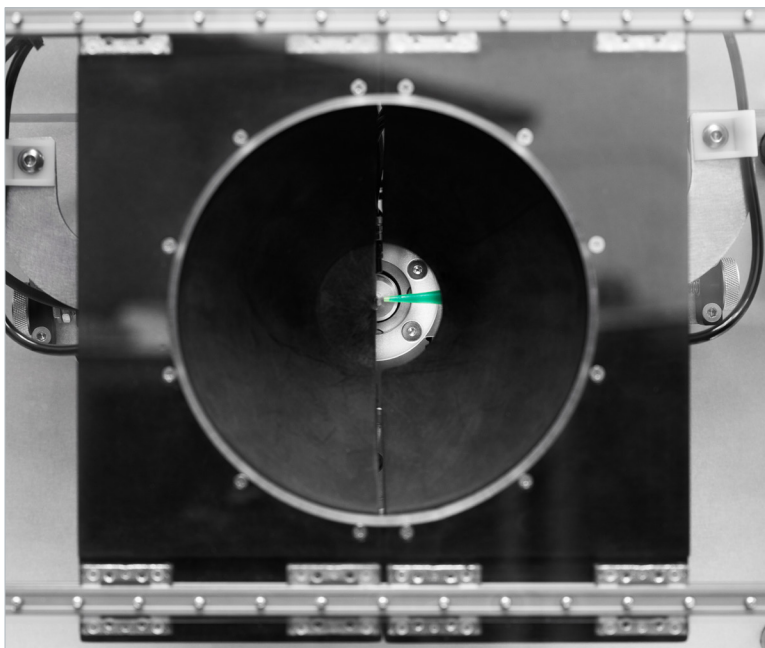

Tooling for a range of applications

Modular components like the tube mandrel, cone insert guide, and dispensing tips offer versatility for various tube sizes and applications.



Live Process Verification and Control via HMI

The intuitive touchscreen HMI offers comprehensive control over the system's mechanical functions, including rotational speed and dispense delays, while also providing real-time part count tracking.



System Features & Benefits



Reliable, Repeatable Product Quality

- Automated 360° cycle for repeatable, total coverage
- Precise doses every shot
- Increases throughput and bond quality from tubes to hubs



Reduce Risks of Bonding Failure

- Helps reduce costs and risks associated with misapplied adhesives
- Decreases operator fatigue and increases efficiency



Production Efficiencies

- Increases product reliability and repeatability
- Reduces scrap from failed bonds and wasted adhesive
- Ensures sealing and reduces or eliminates part scrap
- Ensures full seal for blood-borne pathways

Applications

The RotoSpense 360 is suited for a number of applications. Below are a few typical uses.



Medical and Life Science Devices

- Precision tube sets
- Y connectors and other fluid control products
- Manifold assembly



Imaging and Diagnostic Equipment

- Catheter cameras
- Scopes

How it Works

1

Insert

Insert tubing into the tube mandrel via the RotoSpense 360 face.

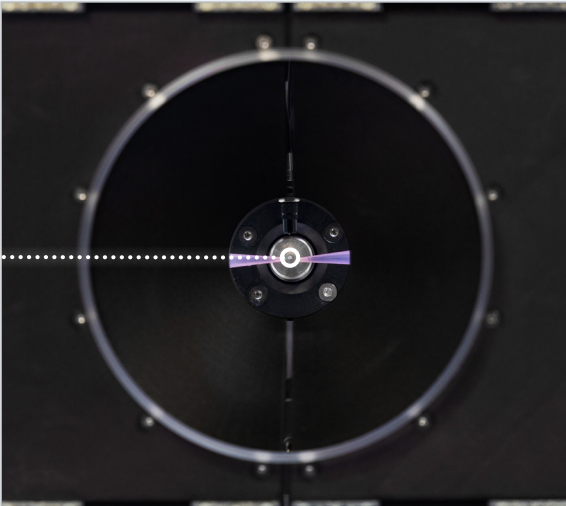
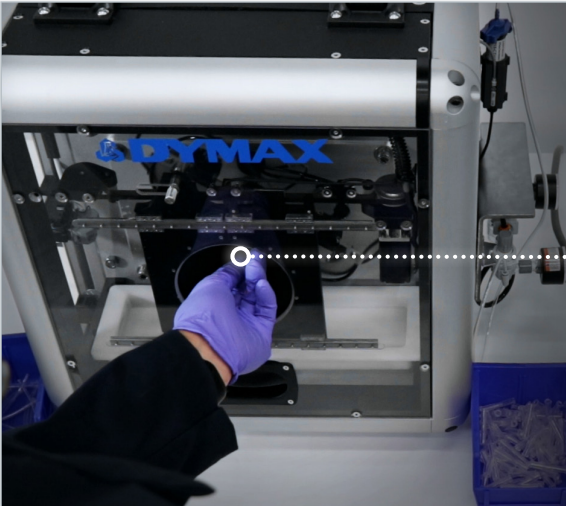

2

Tube Detection

The tube presence sensor detects when a tube is inserted, prompting the system to start.

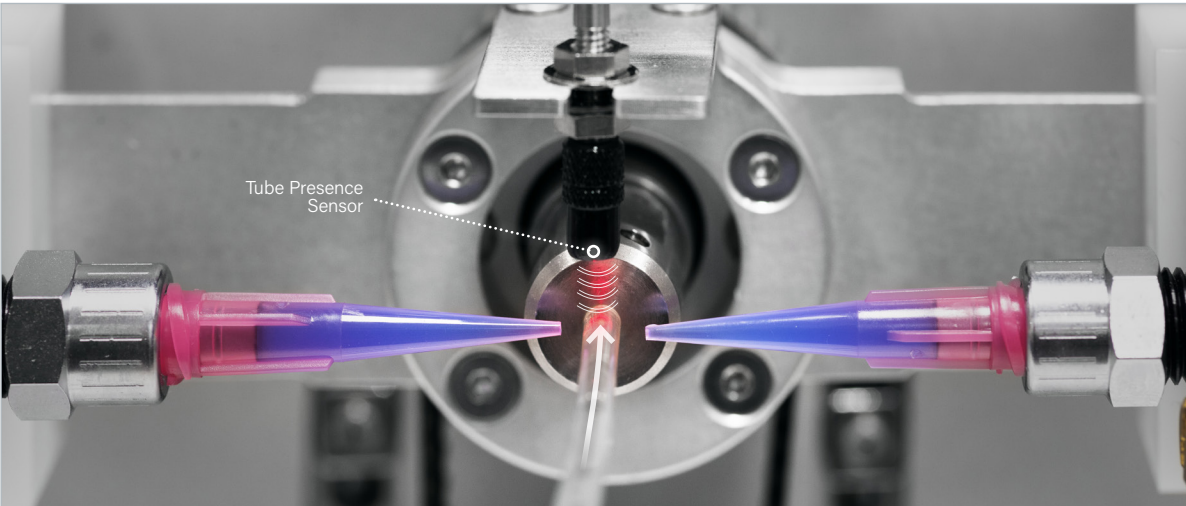

3

Dispense + Rotation

The dual-integrated Dymax Model 455 valves rotate completely around the tube, dispensing the precise amount of adhesive required for the application.

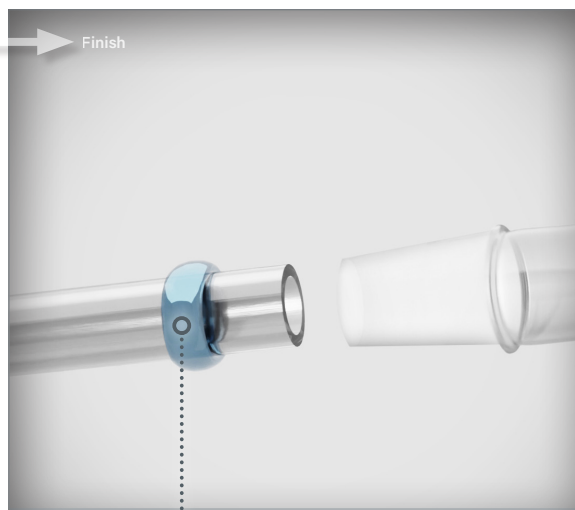
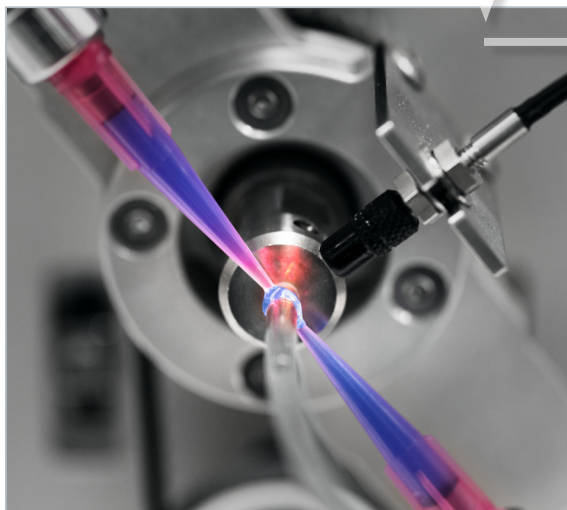
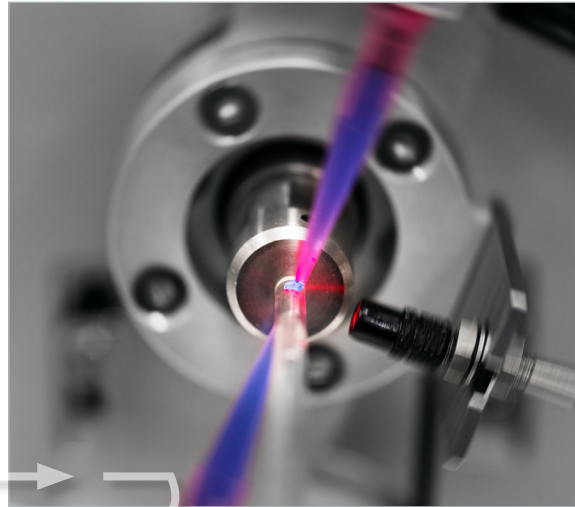
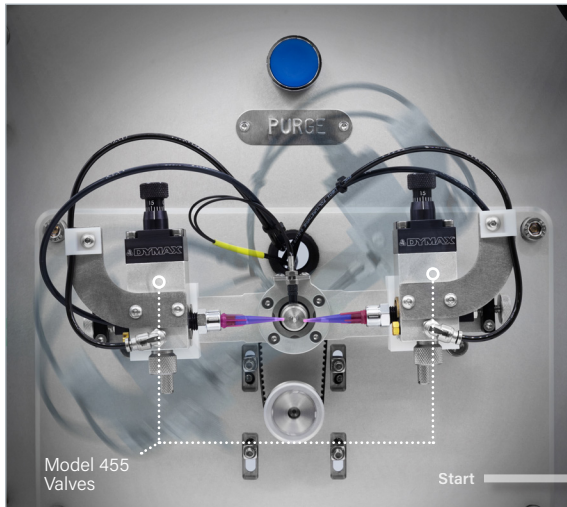

Uniform material dosages to ensure more consistent tube set & catheter assembly processes.

System Specifications

Property	Specification
Power Requirements	Input Voltage: 110 - 120VAC
Air Requirements	Input: 5 - 100 psi (0.34 - 6.9 bar) Main Regulator Output: 1 - 100 psi (0.1 - 6.9 bar) Precision Regulator Output: 1 - 60 psi (0.1 - 4.1 bar)
Dispense Time	0.01 - 999 seconds
Cycle Speed	20 - 30 cycles per minute
Dimensions (W x D x H)	20.6" x 12.5" x 18.4" (52 cm x 32 cm x 47 cm)
Weight	38 lbs (18 kg)
Compatible Viscosity	Designed for medium to high viscosity
Unit Warranty	1 year from purchase date

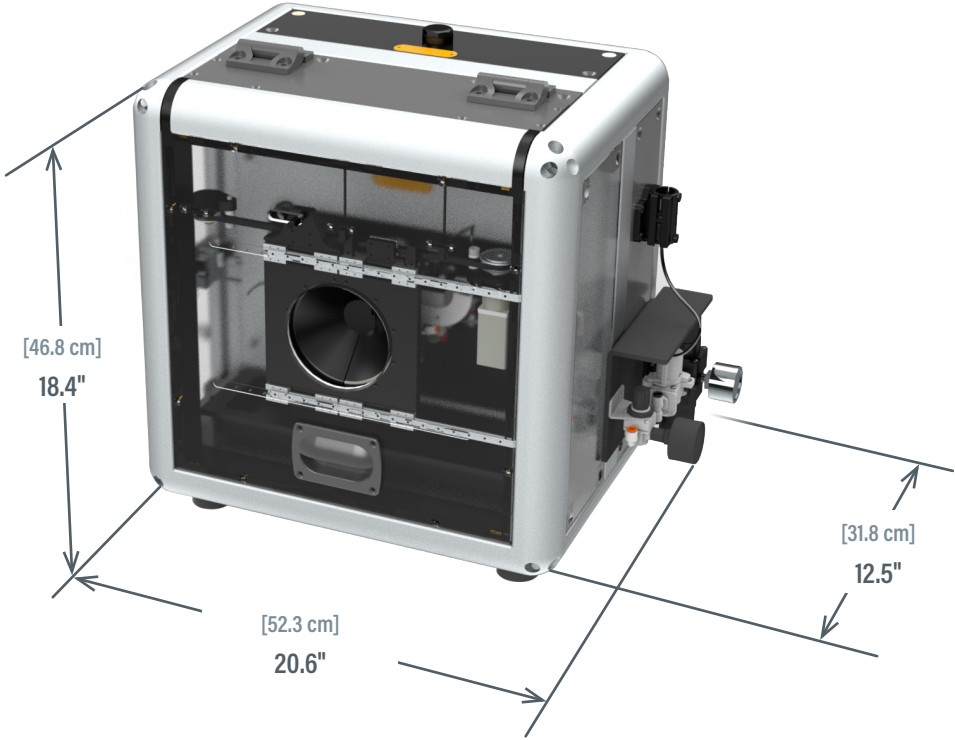

Ordering Information

A complete RotoSpense 360 ships with all the components needed to begin dispensing 360° rings of material. Replacement valves, fluid path replacement parts, additional cone guides, and mandrel part kits are available for purchase if needed.

Units are warranted against defects in material and workmanship for one year from the date of purchase.

Item	
Complete System <i>(includes one set of cone guide inserts and mandrel kit)</i>	
RotoSpense 360 - Complete	T40645
Replacement Valves	
Model 455 Seal Rebuild Kit	T16781
Model 455 Disposable Fluid Path Valve	T10056
Fluid Path Replacement Parts	
PTFE Tubing Assembly, 0.066" [1.68 mm]	T17409
PTFE Tubing Assembly, 0.095" [2.41 mm]	T17554
Polyethylene Tubing Assembly, 0.125" [3.17 mm]	T17557
Tubing Insert, 0.095" [2.41 mm]	T15052
Tube-To-Luer Adapter, Teflon	T15220
Wye Connector Push Connect Fitting	T40574
Dispense Tips 18 ga Taper Luer	P3232
Additional Cone Guide and Mandrel Parts	
Cone Guide Inserts	T40634
Mandrel Kit	T40638

