

# Model 485 Dispensing Systems

User Guide

# Contents

<b>Safety</b> .....	<b>2</b>
Using Safe Operating Pressures .....	3
<b>Configuration Overview</b> .....	<b>3</b>
<b>Key System Connections</b> .....	<b>4</b>
<b>Dispensing Tips</b> .....	<b>6</b>
<b>System Configurations</b> .....	<b>7</b>
A - Systems Using a Cartridge Retainer .....	8
B - Systems Using a Bottle Drop-In Tank.....	10
C - Systems Using a 10-Gallon Pressure Tank .....	13

# Safety

## Using Safe Operating Pressures

Pressurizing the components in the dispensing system beyond the maximum recommended pressure can result in the rupturing of components and serious personal injury. To minimize the risk of rupturing components and injury, do not exceed the maximum operating pressure of the components in your fluid dispensing system.

### Operating Specifications

- Recommended compressed air supply pressure to air filter/regulator = 80 to 100 psi (5.5 to 6.9 bar)
- Recommended pressure setting at air filter/regulator = 75 psi (5.2 bar)
- Maximum pressure setting at air filter/regulator = 100 psi (6.9 bar)
- Power required = 110V power receptacle (customer supplied)

# Configuration Overview

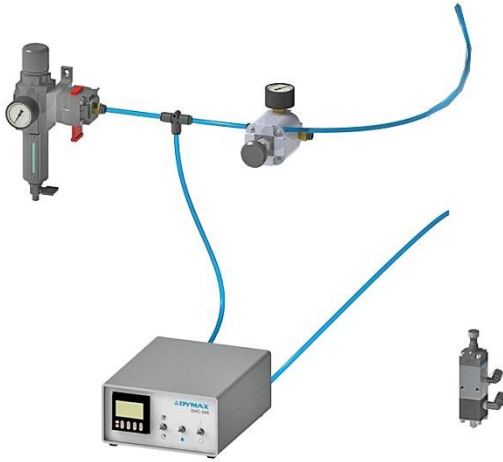

1

## Controls

Dymax valves and digital controller provide precise and consistent actuation.

- Pneumatic function
- Footswitch, manual, or PLC controlled
- Easy to operate
- Manual or timed dispense mode

2

## Dispensing Valve & Accessories

Dymax dispensing valves for handheld and bench-top applications deliver precision solutions for low- to high-viscosity materials. Various style tips and accessories are also available.

3

## Reservoirs

Dymax carries a variety of material reservoirs to accommodate most dispensing applications.

- Range of volumes from 6 oz. cartridges to 10-gallon pressure tanks
- Easy change-over and control

# Key System Connections

NOTE: Figures 1-4 apply to all systems.

**Figure 1.**  
Valve Air & Material Connections

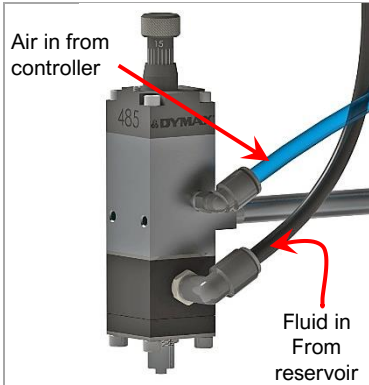

**Figure 2.**  
Controller Connections, Rear Panel

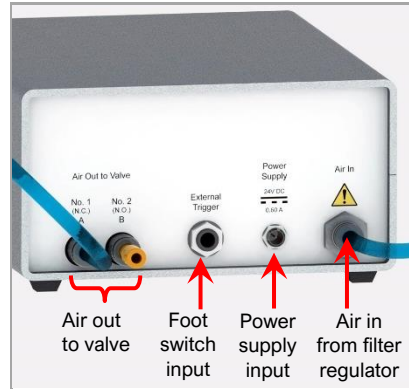

**Figure 3.**  
High-Precision Regulator Connections

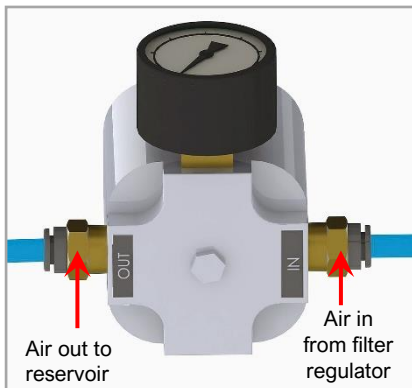

**Figure 4.**  
Filter Regulator

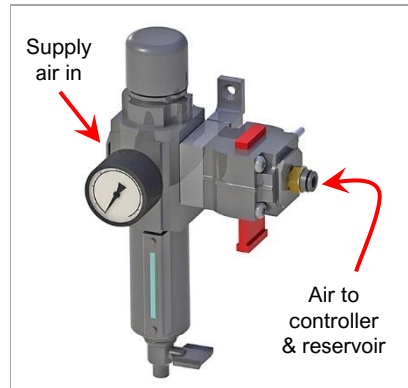





# Dispensing Tips





A variety of both needle and taper dispense tips in various lengths, gauges, and shapes are available from Dymax. Tip selection is critical when precision is required and the length, shape, and size of the tip used will define the shape of the fluid deposit and the performance of your dispense system.

The following tips are included with this system and are recommended for use with the Model 485 dispensing valve. Either tip kit can be used depending on the exact viscosity and application.

## P3424 Dispensing Tip Kit for Low-Viscosity Materials (<500 cP)

Part #	Color	Description	
P3171	Purple	21 GA Needle Tip	
P3172	Orange	23 GA Needle Tip	
P3233	Pink	20 GA Tapered Tip	
P3247	Red	25 GA Tapered Tip	

## P3423 Dispensing Tip Kit for Medium- to High-Viscosity Materials (>500 cP)

Part #	Color	Description	
P3169	Amber	15 GA Needle Tip	
P3170	Green	18 GA Needle Tip	
P3232	Green	18 GA Tapered Tip	
P3247	Red	25 GA Tapered Tip	

For assistance in optimal tip selection, contact Dymax Application Engineering. Visit [www.dymax.com](http://www.dymax.com) to see Dymax's dispensing tip selection.

# System Configurations



**A**

Systems Using a Cartridge Retainer (p. 8-9)

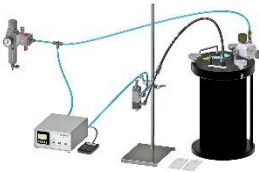

**B**

Systems Using a Bottle Drop-In Tank (p. 10-12)



**C**

Systems Using a 10-Gallon Pressure Tank (p. 13-15)

# A - Systems Using a Cartridge Retainer

## Packaged Components

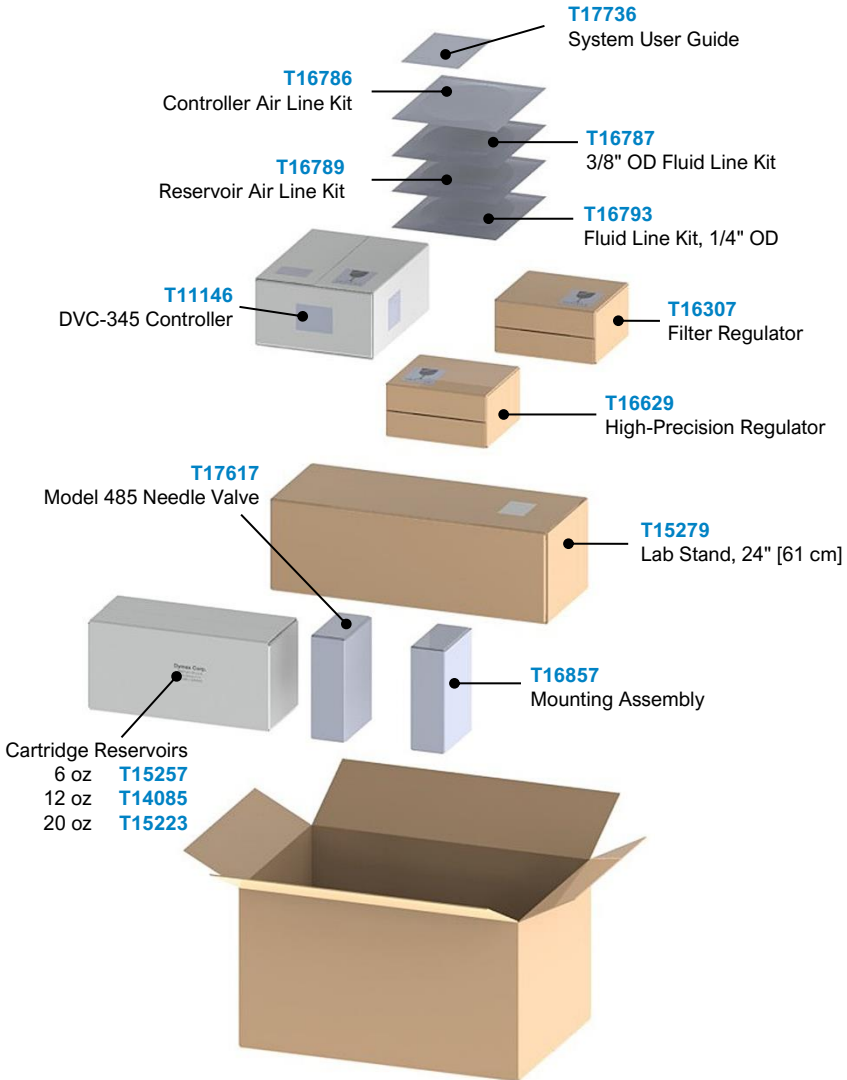



# Assembled System

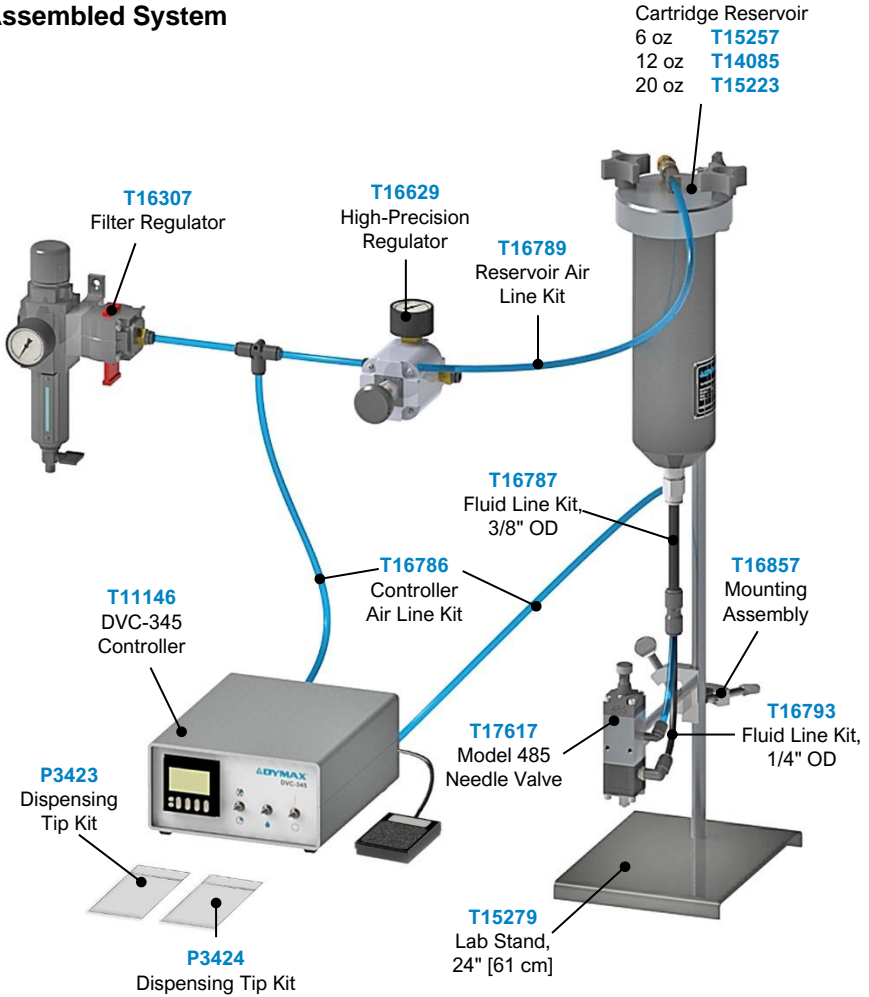

User Supplied Items	Spare Parts
80-100 psi air supply, 1/4 NPT male fitting 110V power receptacle	1/4" male to 1/4" quick-disconnect fitting

## B - Systems Using a Bottle Drop-In Tank

### Packaged Components

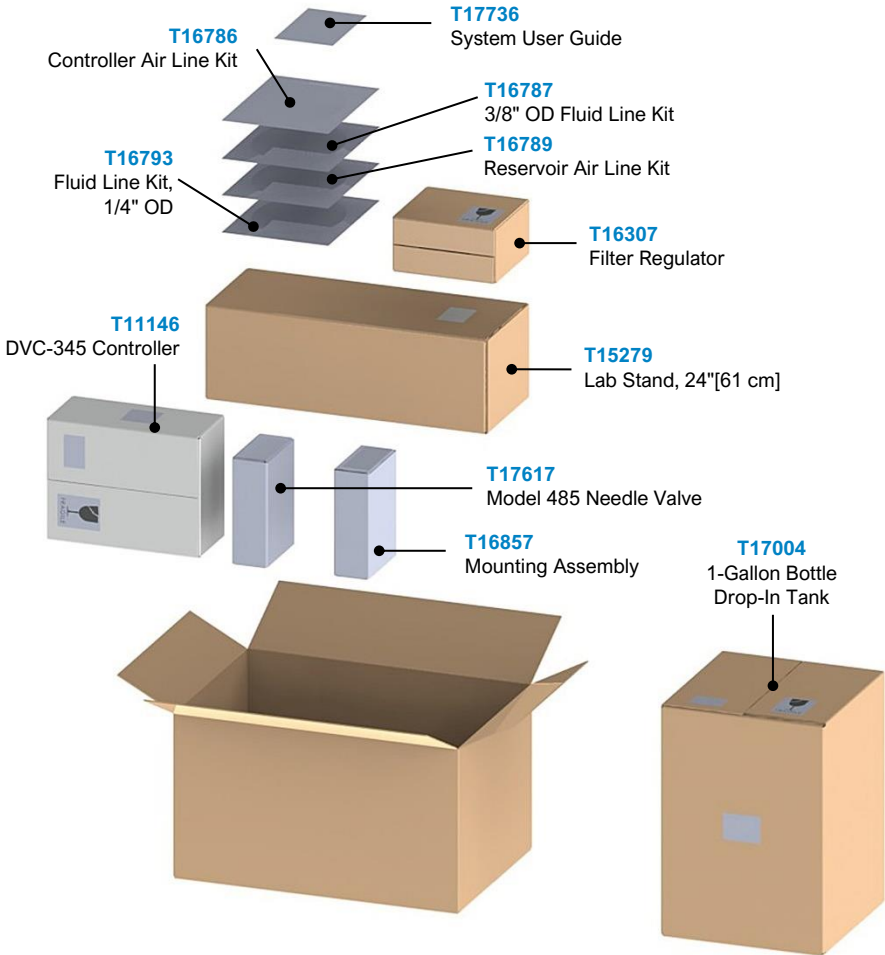

## Assembled System

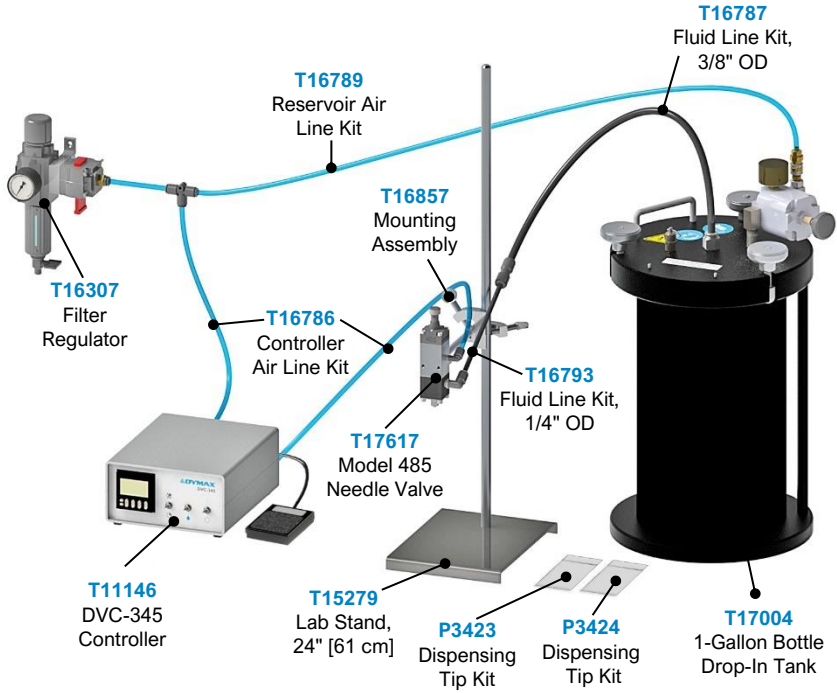

User Supplied Items	Spare Parts
80-100 psi air supply, 1/4 NPT male fitting 110V power receptacle	1/4" male to 1/4" quick-disconnect fitting

## Installing the Fluid Line to the Reservoir

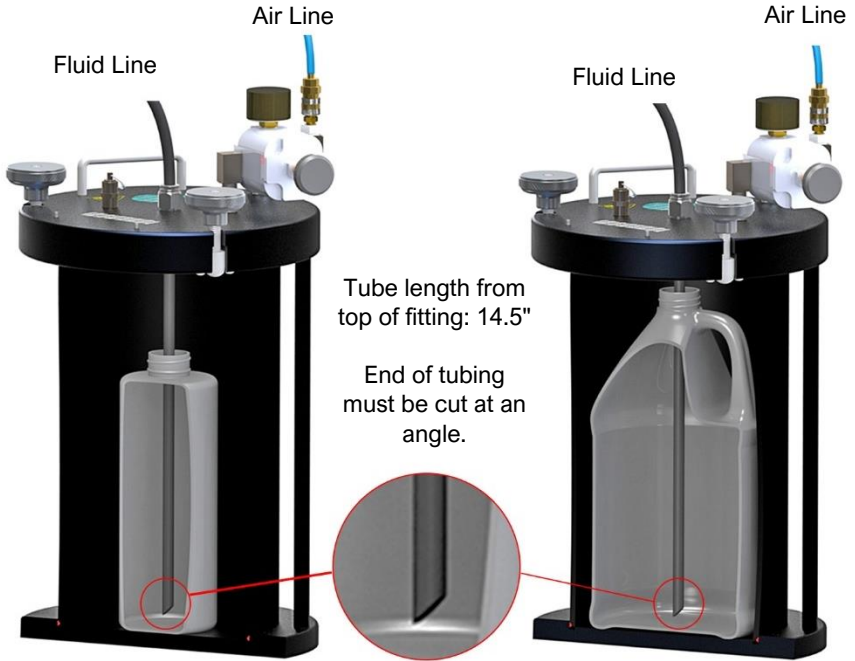

**1-Liter Bottle**

**1-Gallon Bottle**

# C - Systems Using a 10-Gallon Pressure Tank

## Packaged Components

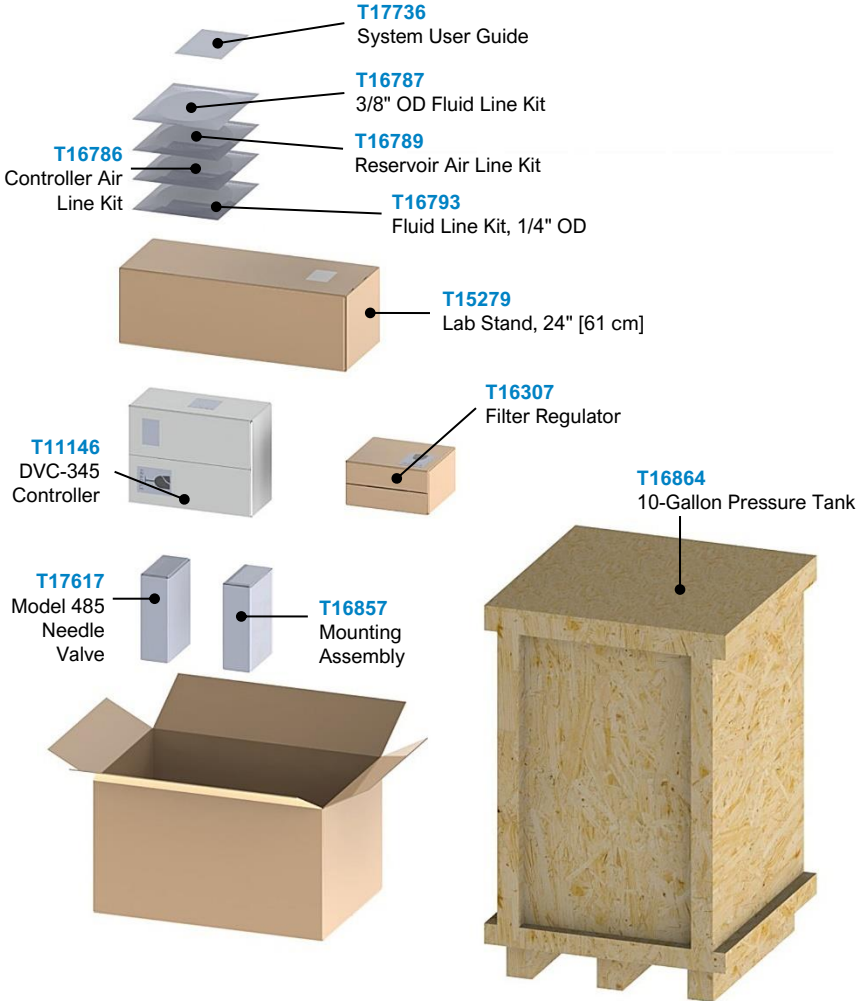

## Assembled System

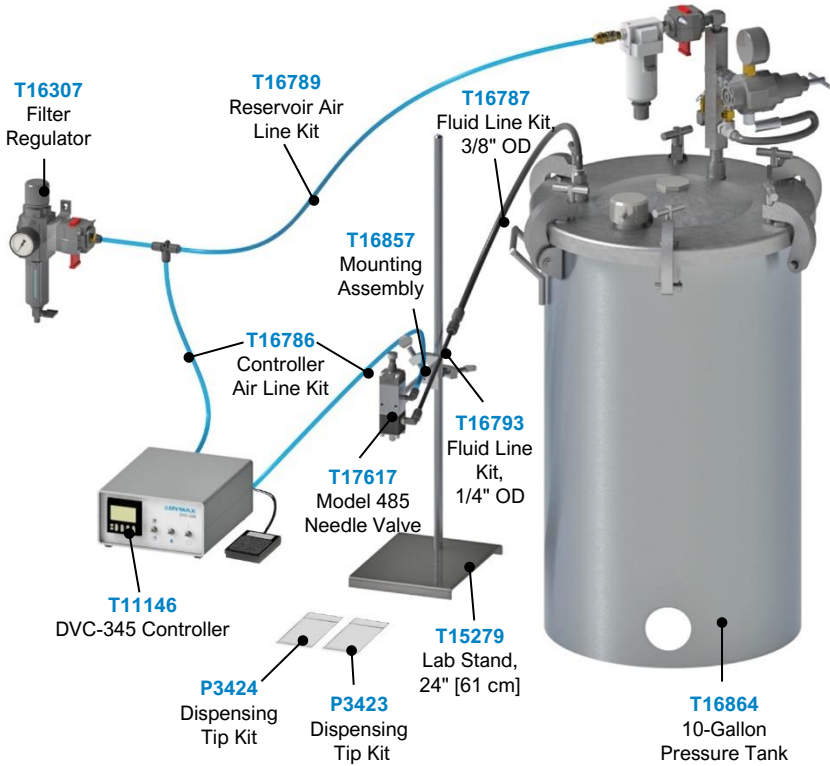

User Supplied Items	Spare Parts
80-100 psi air supply, 1/4 NPT male fitting 110V power receptacle	1/4" male to 1/4" quick-disconnect fitting

## Installing the Fluid Line to the Reservoir

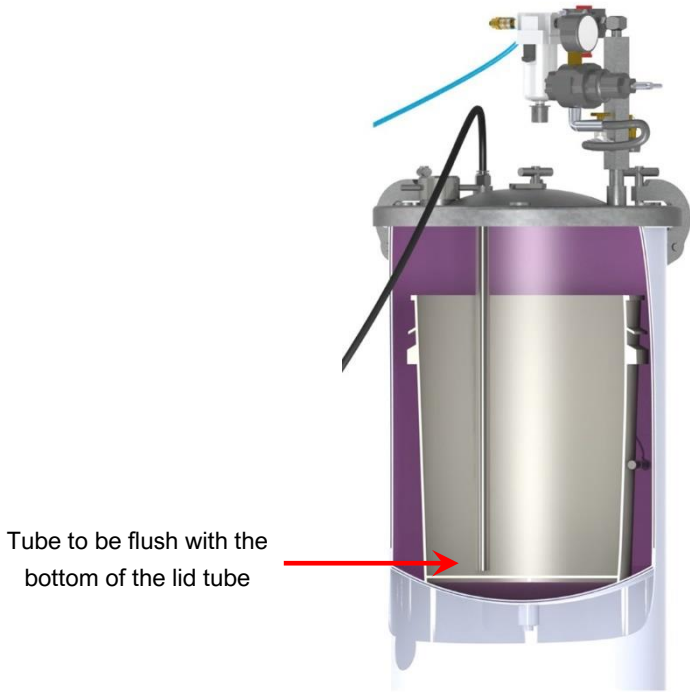

**15-Liter Pail**



#### Americas

USA | +1.860.482.1010 | [info@dymax.com](mailto:info@dymax.com)

#### Europe

Germany | +49 611.962.7900 | [info\\_de@dymax.com](mailto:info_de@dymax.com)

Ireland | +353 21.237.3016 | [info\\_ie@dymax.com](mailto:info_ie@dymax.com)

#### Asia

Singapore | +65.67522887 | [info\\_ap@dymax.com](mailto:info_ap@dymax.com)

Shanghai | +86.21.37285759 | [dymaxasia@dymax.com](mailto:dymaxasia@dymax.com)

Shenzhen | +86.755.83485759 | [dymaxasia@dymax.com](mailto:dymaxasia@dymax.com)

Hong Kong | +852.2460.7038 | [dymaxasia@dymax.com](mailto:dymaxasia@dymax.com)

Korea | +82.31.608.3434 | [info\\_kr@dymax.com](mailto:info_kr@dymax.com)

© 2013 Dymax Corporation. All rights reserved. All trademarks in this guide, except where noted, are the property of, or used under license by Dymax Corporation, U.S.A. Delrin and Teflon are registered trademarks of DuPont.

The data contained in this bulletin is of a general nature and is based on laboratory test conditions. Dymax Europe GmbH does not warrant the data contained in this bulletin. Any warranty applicable to products, its application and use is strictly limited to that contained in Dymax Europe GmbH's General Terms and Conditions of Sale published on our website. Dymax Europe GmbH does not assume any responsibility for test or performance results obtained by users. It is the user's responsibility to determine the suitability for the product application and purposes and the suitability for use in the user's intended manufacturing apparatus and methods. The user should adopt such precautions and use guidelines as may be reasonably advisable or necessary for the protection of property and persons. Nothing in this bulletin shall act as a representation that the product use or application will not infringe a patent owned by someone other than Dymax Corporation or act as a grant of license under any Dymax Corporation Patent. Dymax Europe GmbH recommends that each user adequately test its proposed use and application of the products before actual repetitive use, using the data contained in this bulletin as a general guide. MAN060EU T17736 11/4/2013